



UNIVERSITÀ
DEGLI STUDI
FIRENZE

DIPARTIMENTO
DI INGEGNERIA
INDUSTRIALE

Firenze Race Team

- Passato, presente e futuro -

Cos'è la Formula SAE?



Cos'è la Formula SAE?



Chi siamo noi?

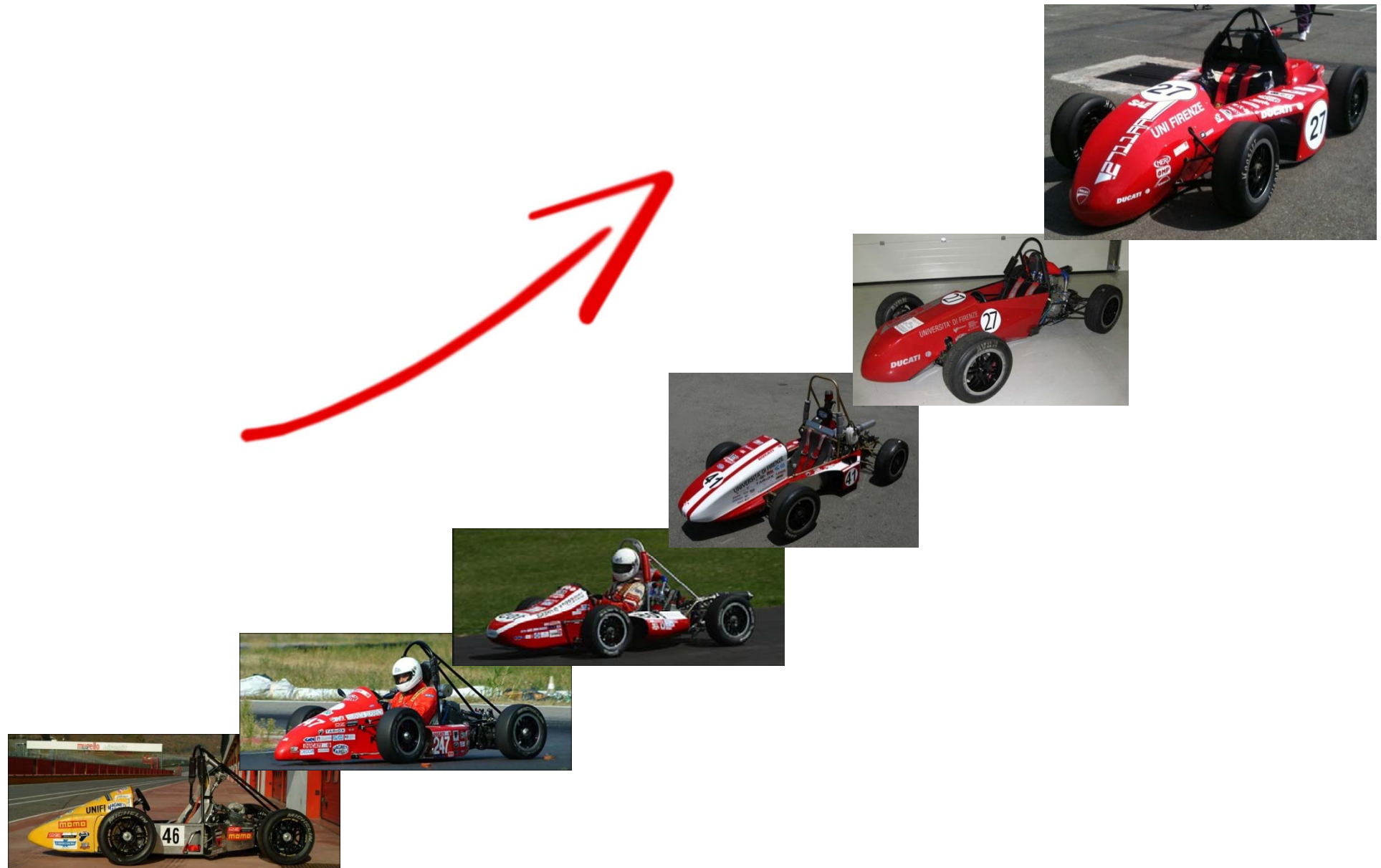

Chi siamo noi?



UNIVERSITÀ
DEGLI STUDI
FIRENZE



Valore: teamwork



UNIVERSITÀ
DEGLI STUDI
FIRENZE





Valore: linguaggio tecnico



UNIVERSITÀ
DEGLI STUDI
FIRENZE

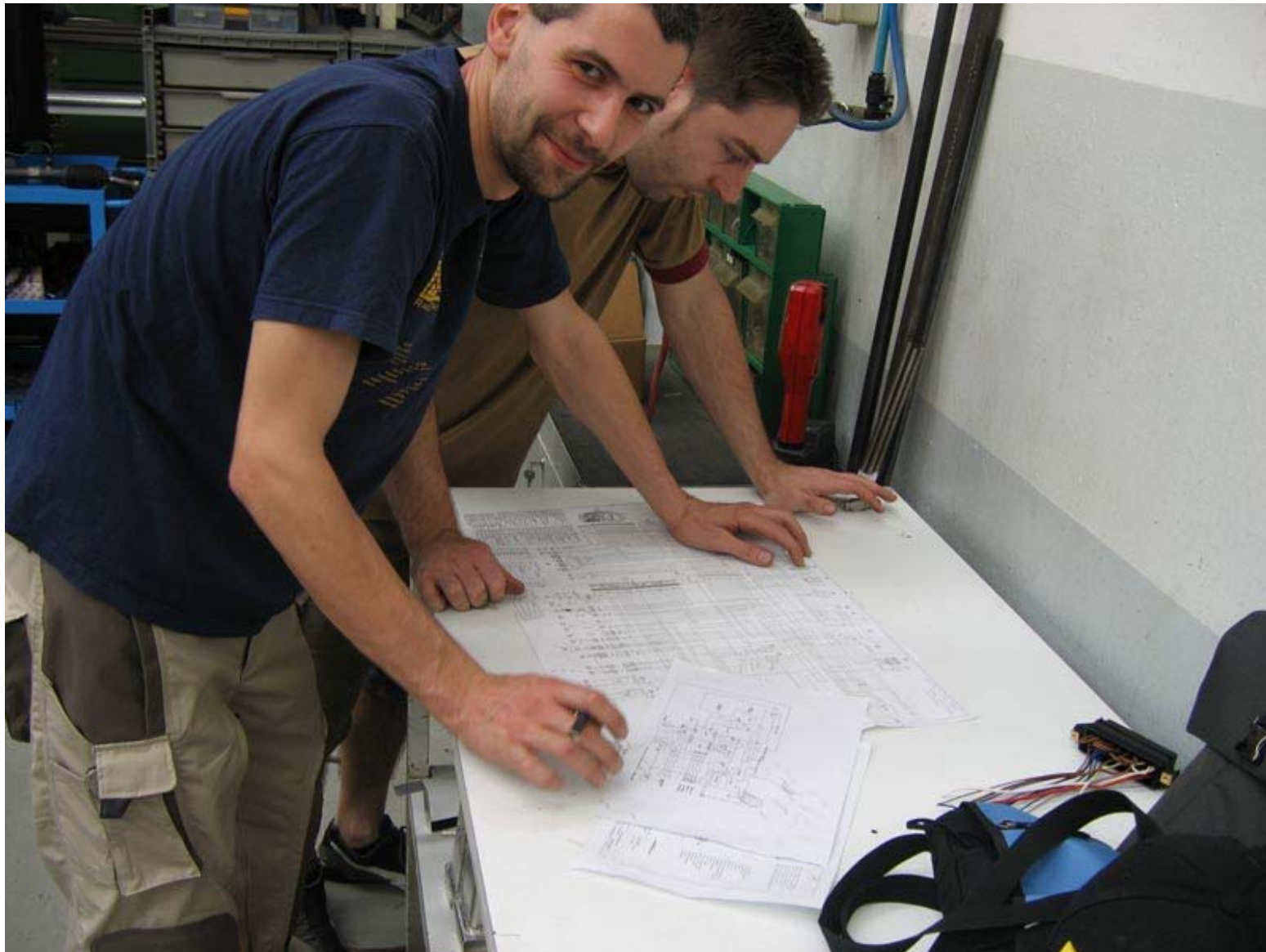



Una porta sul mondo del lavoro



UNIVERSITÀ
DEGLI STUDI
FIRENZE

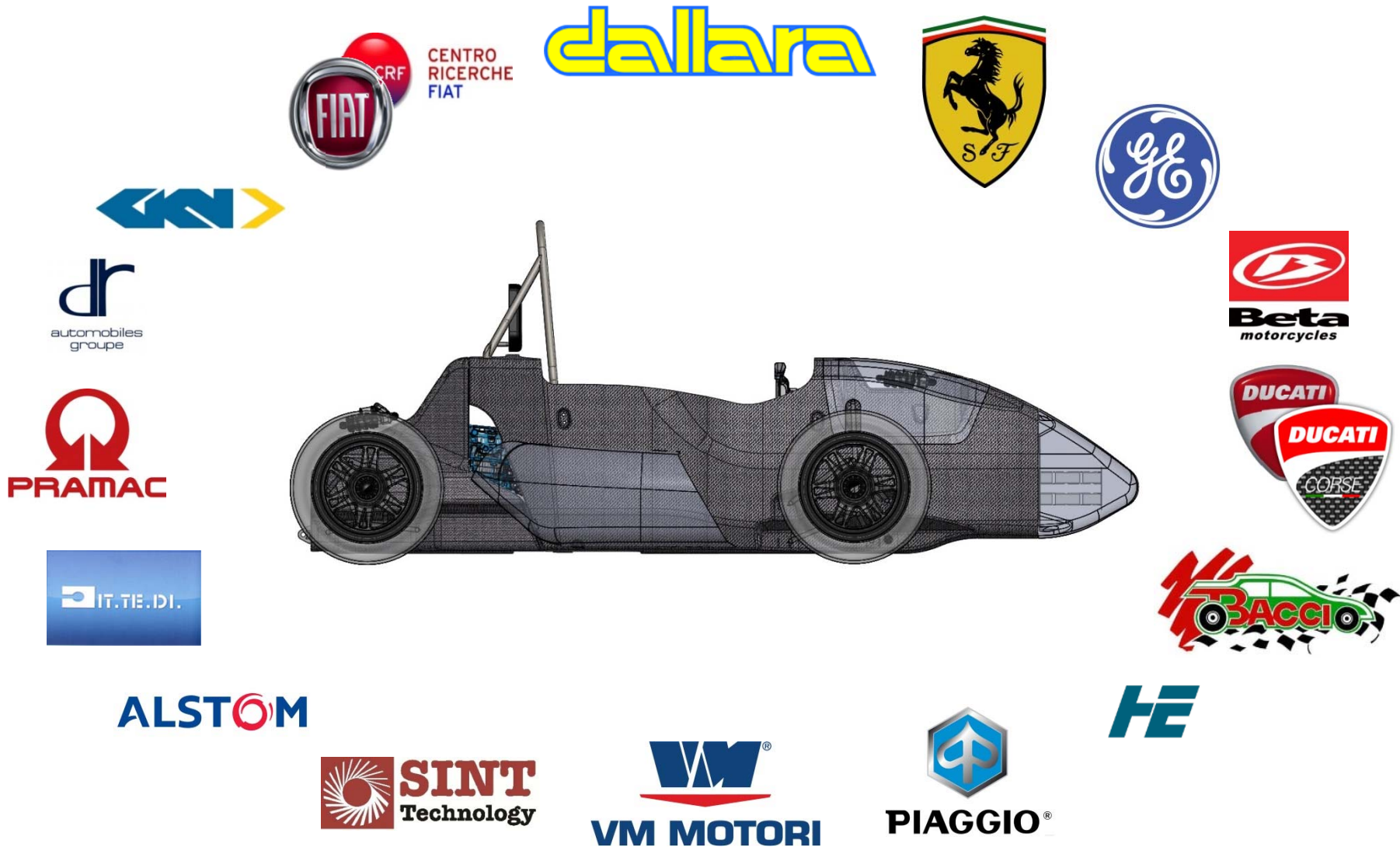

E tante altre...

Racecar engineering

ETH Zurich makes history at Formula Student

By Sam // July 11, 2013



An electric vehicle has won an FSAE event outright against combustion cars for the first time in the competition's history.

ETH Zurich, from Switzerland, stormed to victory with an extraordinary total of 921.3 points. It is believed to be the first time that an electric vehicle has beaten cars powered by combustion engines in any accredited motorsport competition.

Valore: diffusione

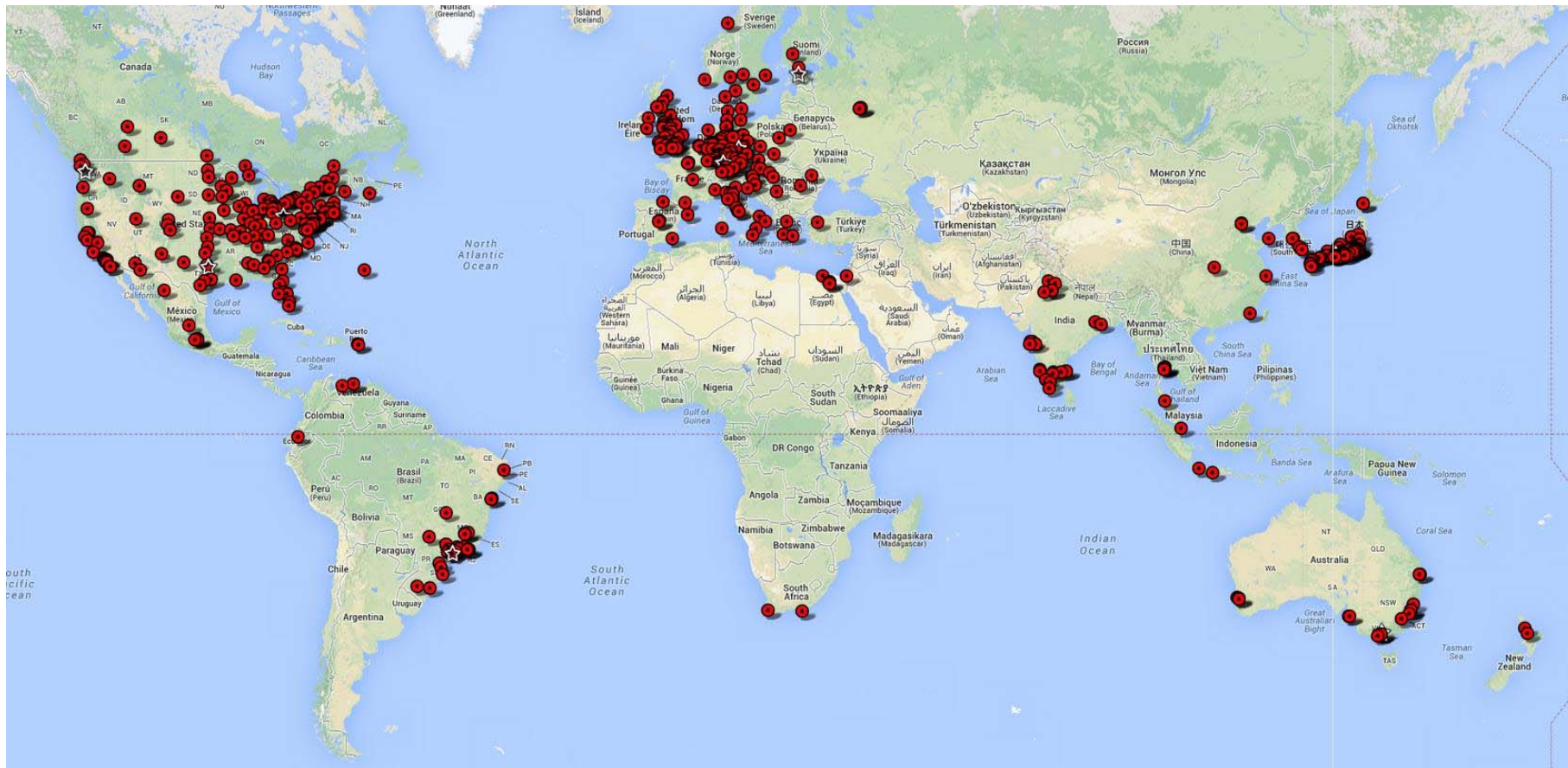

Circa 600 team di FSAE in tutto il mondo...

Valore: 'Area VIP'



UNIVERSITÀ
DEGLI STUDI
FIRENZE





RECRUITMENT CAMPAIGN SQUADRA CORSE

THE POLITECNICO TEAM IS WAITING FOR YOU.
LIVE YOUR PASSION !

All the faculties for an international competition,
Formula SAE.



ENGINEERING
DESIGN
GRAPHICS

SquadraCorse
Politecnico Torino





DESIGN

YOU HAVE ENOUGH OF STUDYING ?

Practice what you study in a real and important project.



LEARN

YOU WANT TO MEET AND CONFRONT WITH REAL DESIGNERS ?

Prove yourself and work with real experts.



COMPETE

ARE YOU AN AMBITIOUS PERSON ?

Compete at international levels in a world competition.

www.squadracorse-polito.com



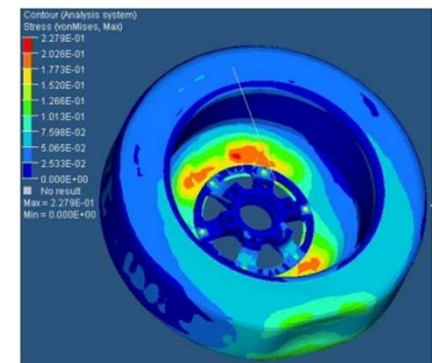
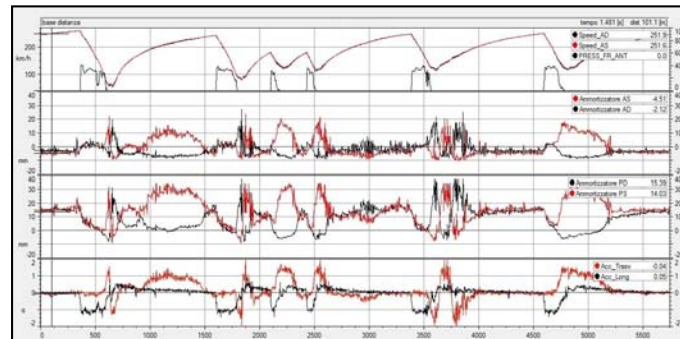
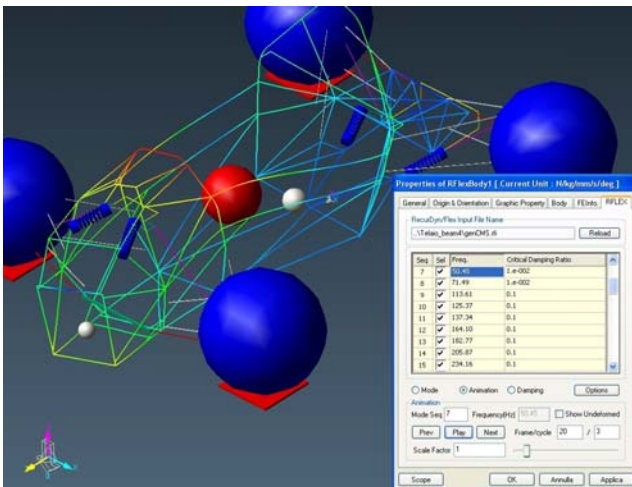
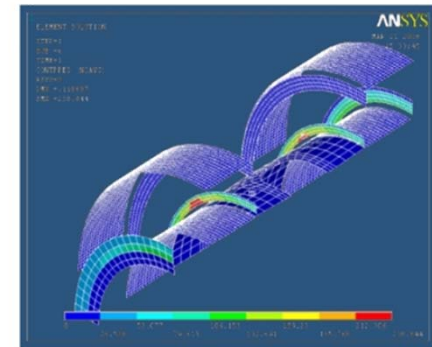
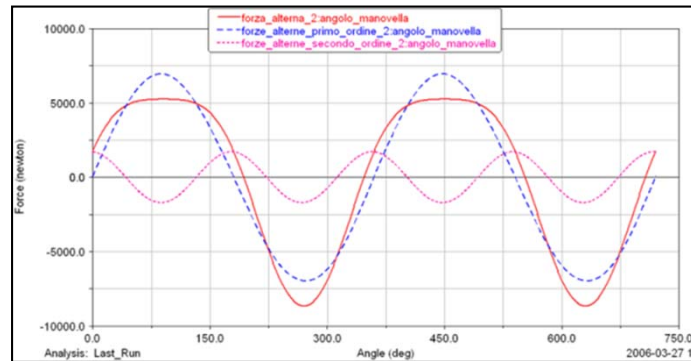
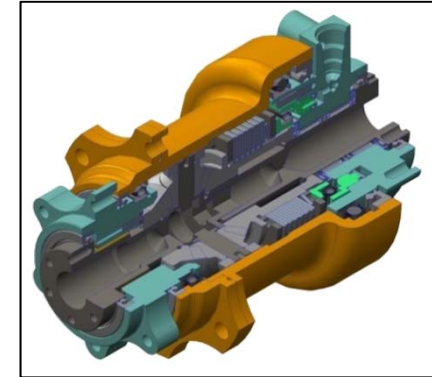
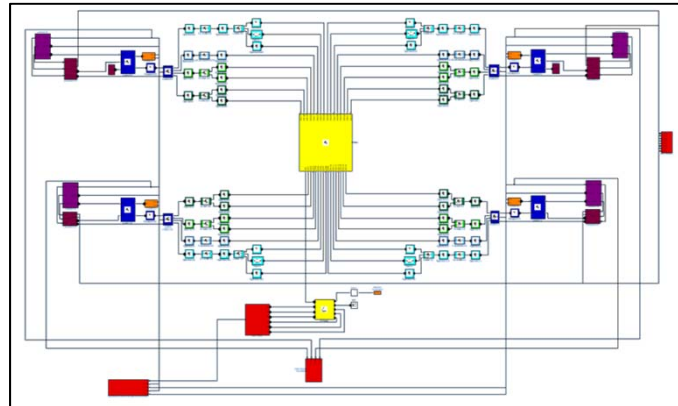
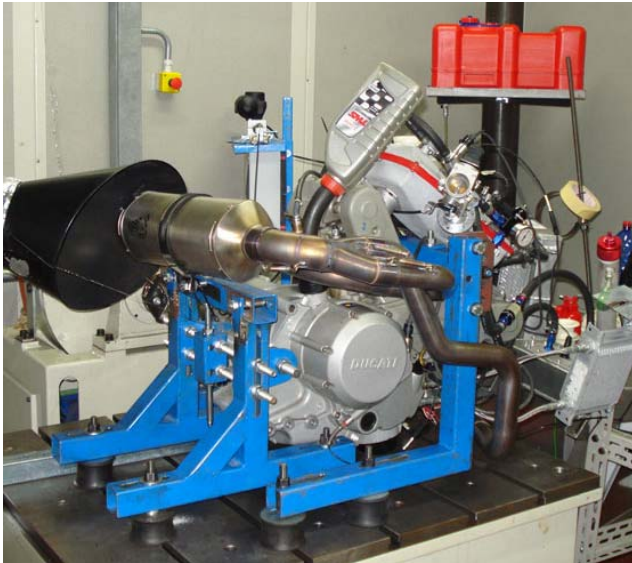

Valore: veicolo marciante e strumentato



UNIVERSITÀ
DEGLI STUDI
FIRENZE



Interesse del mondo industriale



UNIVERSITÀ
DEGLI STUDI
FIRENZE



E tante altre...



Budget necessario (stima dei costi di realizzazione e trasferta)



Totale: €85,000.00

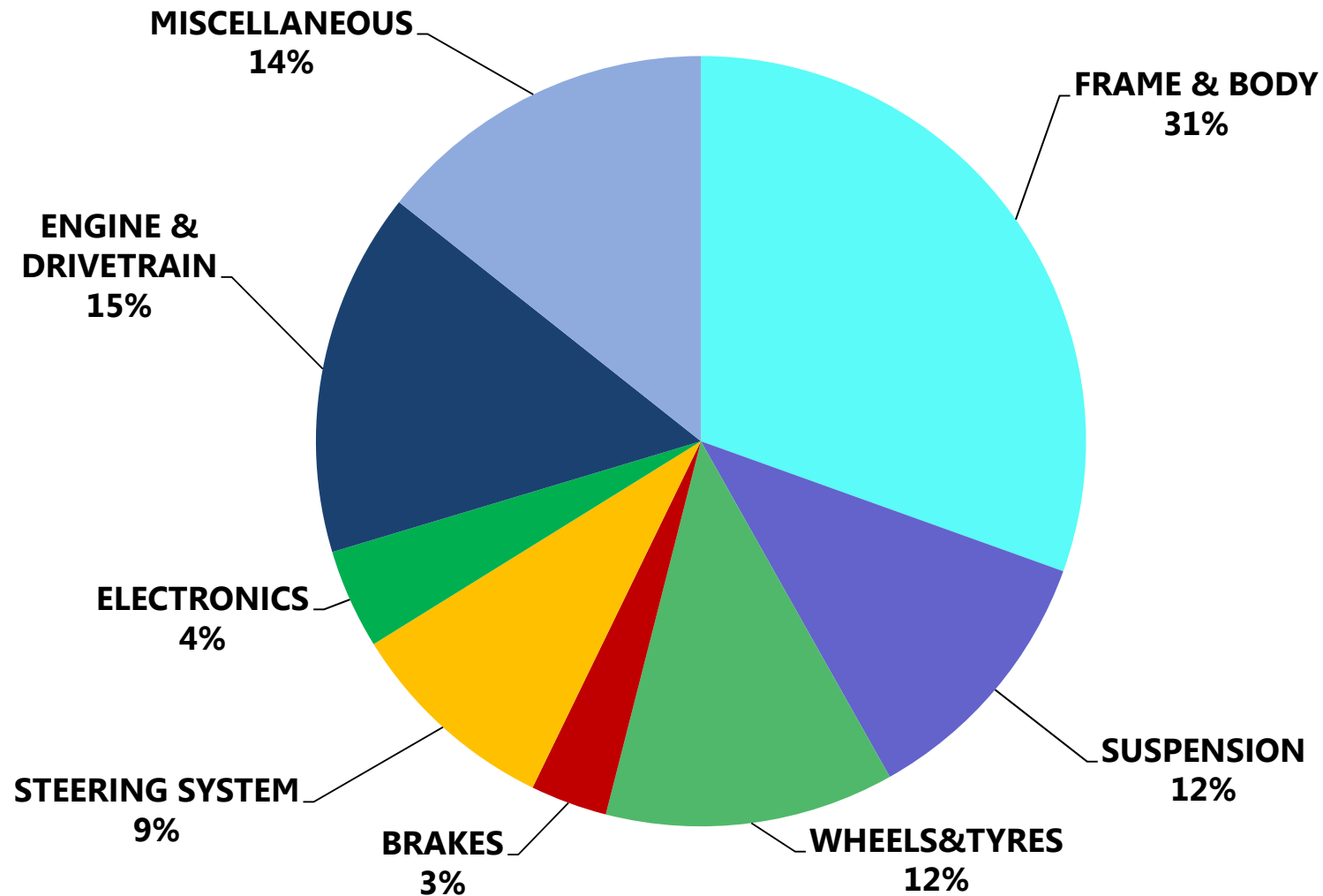

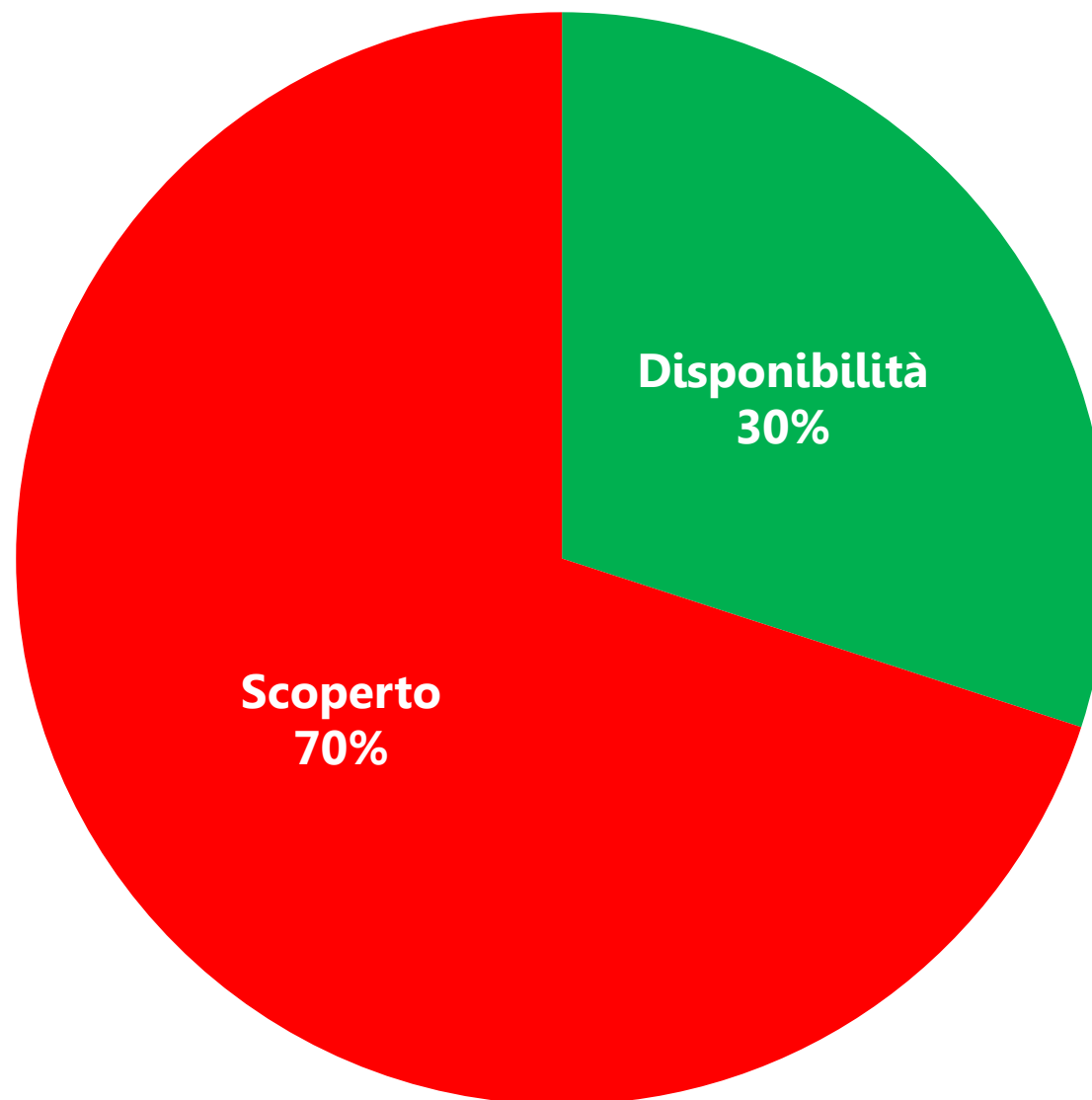







A noi piacerebbe diventare così





UNIVERSITÀ
DEGLI STUDI
FIRENZE

DIPARTIMENTO
DI INGEGNERIA
INDUSTRIALE

Firenze Race Team

